

MaxMotion

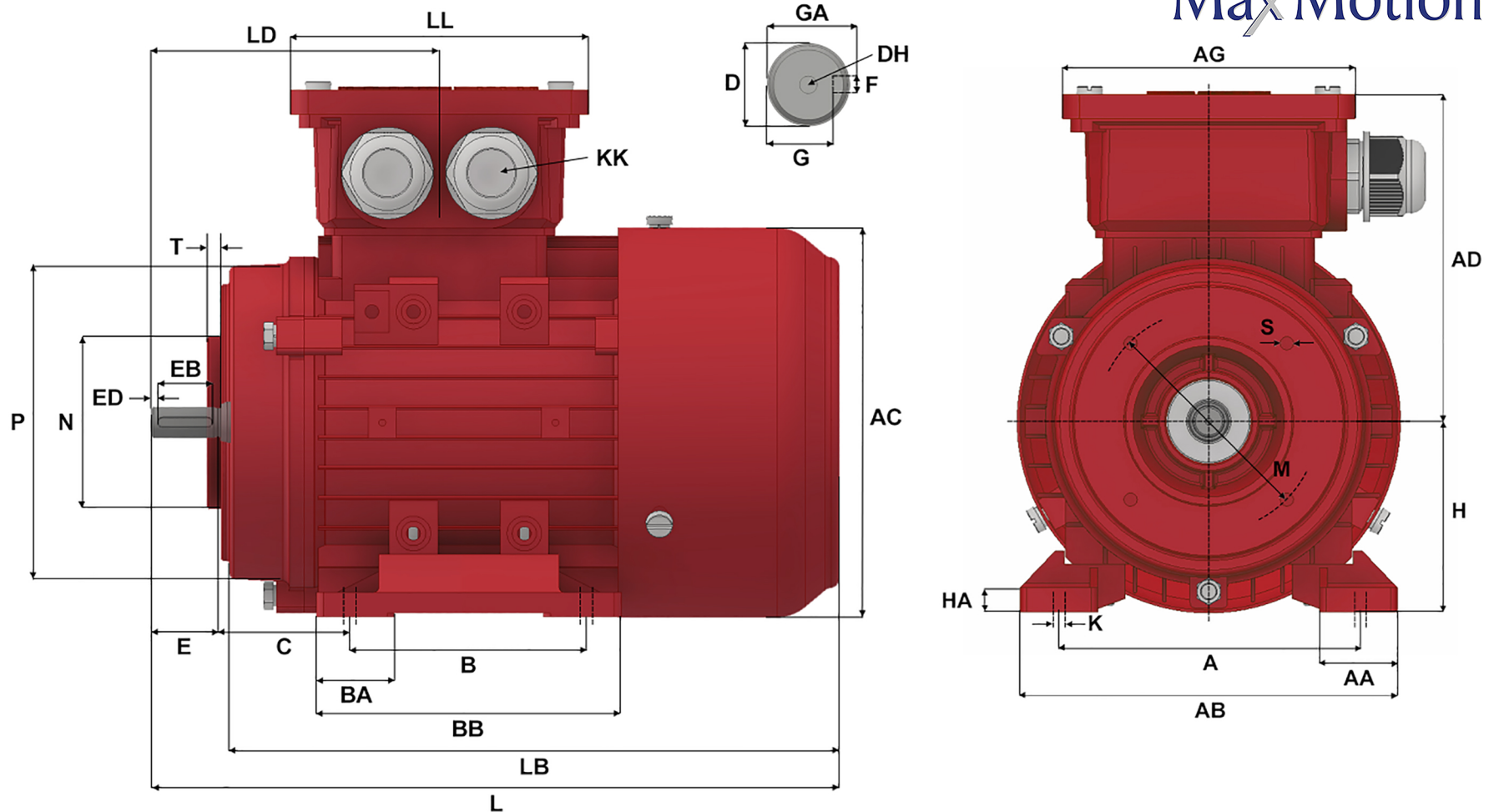

Version: 1JLEM		Revised: 09-11-2019				HP	RPM	FRAME	ENCLOSURE	IJA711-6-B34A			
Customer is responsible in determining that Max Motion product will fit/perform suitably in the intended application						0.25	1020	71	TEFC				
A	B	C	D	E	F	G	H	K	L	M	N	P	
112	90	45	14	30	5	11	71	7 X 11	245	85	70	105	
S	T	AA	AB	AC	AD	AG	BA	BB	DH	EB	ED	GA	
M6	2.5	26	138	136	112	101	26	110	M5 X 12	25	2.5	16	
HA	KK (1)	KK (2)	KK (3)	LB	LD	LL							
8	M20 X 1.5	1/2" NPT	-	215	110.5	101							